

PRESENTATION

PNEUMATIC ROPE BALANSER

BFCS75 WITH CLAWS

The pneumatic balancers are particularly suitable for the rapid handling of loads on the production lines.



Specifications

The standard column execution includes an articulated arm with a working radius of 3 m. Inside the external arm a balancing device with a lifting capacity of 75 Kg is housed. Both the rotation of the arm around the column, and on the articulation between the two arms is 360° continuous, thanks to the internal air passages. The column can be fixed directly to the floor or mounted on a self bearing fork liftable base, in order to be used in different work places.

WHO WE ARE



MANIBO holds a consolidated position in the field of industrial manipulation and is now a reference partner for many leading Companies not only in Italy, but throughout the world. MANIBO takes particular care in solving handling problems in the food and pharmaceutical Companies, also with applications in ATEX environments. We guarantee timely responses and rapid decisions.



Safety Devices

- » Locking valve for raising and lowering the rope and any gripping tool in case of a sudden lack of compressed air supply
- » Parking brakes on joints against spontaneous arm movements (optional)
- » Valve cuts flow to prevent sudden ascents of the rope due to operating errors

WHY CHOOSE US

-  Our experience, professionalism and precision.
-  Particular attention in the testing phase, with specific tests for the use, even in ATEX environments.
-  Accurate design phase to adapt the manipulator to your machine and to your environment conditions.



Accessories

The balancer can be supplied with a simple rotating hook, or complete with a custom-made gripping tool for moving a specific object.

CONTACT US FOR A QUOTE

Different options

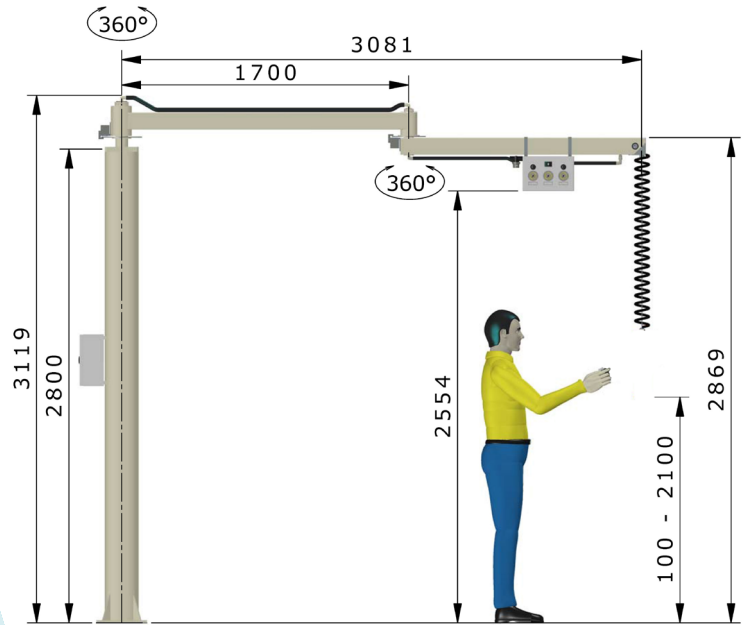
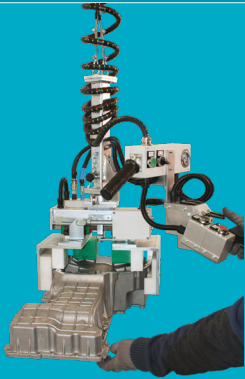
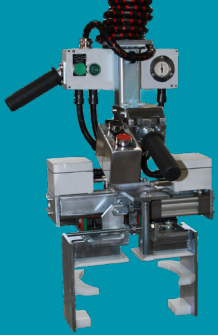
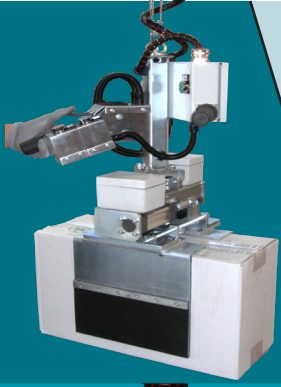

Technical features:

- Air pressure supplied at 7 bar
- Gross capacity 75 kg
- Max working radius 3080 mm
- Rotation around the Column 360° continuous
- Articulated arm rotation 360° continuous
- Useful vertical stroke 100 - 2100 mm
- Maximum instant air consumption 240 NI / min

Pneumatic gripper with two self-centering jaws

The pneumatic gripping device can be designed to lift drums, reels, motors, boxes etc. We can provide gripping tools that grips parts from their internal side even in cases with different shapes or sizes.

The balancer can be equipped with a flexible ergonomic or extended handle. The balancer is additionally equipped with special safety devices to prevent the sudden release of the lifted part in mid-air. The release of the part is possible only when it lays firmly on a surface.



SCAN ME



Via del Lavoro 85, 40033
Casalecchio di Reno BO



+39 (0)51 6468143



www.manibo.eu
manibo@mani-bo.com